

Serial Number:	
Model:	

ACCUSTEAM[™]
HIGH PRODUCTION GRIDDLE

INSTALLATION/OPERATORS MANUAL ACCUSTEAM GAS G2 GRIDDLE

MODELS

GG24A/GG36A/GG48A

GG24B/GG36B/GG48B

PG24A/PG36A/PG48A

PG24B/PG36B/PG48B



Please scan this QR code to register the unit for warranty and receive your free Scotch-Brite[™] Griddle Cleaning Kit

This manual should be retained for future reference

WARNING

The State of California enacted the California Safe Drinking Water and Toxic Enforcement Act of 1986, (Prop. 65), which “prohibits any person in the course of doing business from knowingly and intentionally exposing any individual to a chemical known to the State of California to cause cancer or reproductive toxicity without first giving clear and reasonable warning to such individuals.” The Governor’s Scientific Advisory Panel added Carbon Monoxide to the list of hazardous chemicals known to cause reproductive harm.

In order to establish full compliance with Proposition 65, a yellow warning label has been attached to each gas fired unit manufactured by AccuTemp Products, Inc.

Carbon monoxide would not be present in concentrations that would pose a “significant risk” to the consumer when the equipment is installed, operated and maintained as follows:

1. Installed in accordance with all local codes, or in the absence of local codes, with the current National Fuel Gas Code Z223.1, latest addenda.
2. Installed under a properly designed and operating exhaust hood.
3. Connected to the type of gas for which the unit is equipped.
4. Proper appliance pressure regulator installed on the gas supply line and adjusted for the manifold pressure marked on the rating plate.
5. Adequate air supply to the unit and adequate clearance around the flue.
6. The equipment is operated in the manner intended using the proper utensil for that type of appliance.
7. Keep the equipment clean and have it checked periodically.
8. Burner air adjustments, mechanical maintenance and repairs should be performed by qualified service personnel.

TABLE OF CONTENTS

SAFETY WARNINGS INFORMATION	PAGE 3
GENERAL INFORMATION	PAGE 7
START UP FORM	PAGE 10
INSTALLATION	PAGE 12
OPERATION - USE	PAGE 19
OPERATION - CLEANING	PAGE 29
PLANNED MAINTENANCE	PAGE 30
SERVICE & TROUBLESHOOTING	PAGE 33
WARRANTY	PAGE 36

DOCUMENT HISTORY

CURRENT REVISION	DATE	PRIOR REVISION	DATE	CHANGE
2501	1/13/2025	2403	3/27/2024	Revised Start up form.
2403	03/27/2024	2208	08/26/2022	Revision of control programming
2208	08/26/2022	2002	02/13/2020	Added QR scan code.
2002	02/13/2020	1907	07/26/2019	Added AccuSteam Stand Installation Instructions
1907	07/26/2019	1809	04/09/2018	Update of company logo
1809	04/09/2018	1612	05/12/2016	Review and update manual
1612	05/12/2016			Original Release

1. WARNING SYMBOL DEFINITIONS

SYMBOL DEFINITIONS

Symbols are used to attract your attention to possible dangers. They are only effective if the operator uses proper accident prevention measures. Some of the symbols are boxed text; while others maybe just picture icons. Please give this information the respect they deserve for safe operation.

Symbol Icons

Below are definitions of the symbol icons used in this manual.



DANGER

Indicates an imminently hazardous situation; which, if unchanged, will result in death or serious injury.



CAUTION

Indicates a potentially hazardous situation; which, if unchanged, will result in minor or moderate injury.



NOTE

Advises the reader of information or instructions, vital to the operation or maintenance of the equipment.



CAUTION - HOT SURFACE

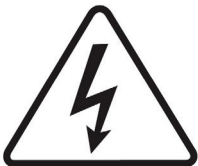

DANGEROUS VOLTAGE

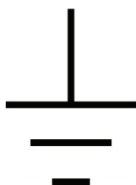

EARTH GROUND

1.1 IMPORTANT FOR YOUR SAFETY

The safety instructions listed below on this page should be posted in a prominent location as a reminder of safe practices as well as recommended actions to follow in the event of an equipment or facility utility issue.

WARNING

In the event a gas odor is detected, shut down all appliances at the main gas shut-off valve and contact the local gas company or gas supplier service.

WARNING

In the event of a power failure, do not attempt to operate this appliance.

WARNING

Do not store or use gasoline or other flammable vapors or liquids in the vicinity of this or any other appliance.

WARNING

Improper installation, adjustment, alteration, service or maintenance can cause property damage, injury or death. Read the installation, operating, and maintenance instructions thoroughly before installing or servicing this equipment.

WARNING

Only qualified service technicians/electricians should install this appliance to ensure that all electrical and safety requirements are met and that all wiring is installed in accordance with all national, state and local electrical codes.

1.2 WARNING & CAUTION NOTES

IMPORTANT: Read the following safety installation to avoid personal injury or death and to avoid damage to the equipment or property

 Improper installation, adjustment, alteration, service or maintenance can cause property damage, injury or death. Read the installation, operating and maintenance instructions thoroughly before installing or servicing the equipment.

 A five minute complete shutoff must be observed before the appliance is relighted.

 Intended for other than household use.

 Plug the appliance into a properly grounded electrical outlet of the correct voltage, size and plug configuration. If they do not match, contact a qualified electrician to determine the proper voltage and size and install the proper electrical outlet.

 Do not connect to a circuit operating more than 150V to ground.

 To avoid any personal injury or damage to the unit do not pull the appliance by the power cord.

 To prevent any injury, discontinue any use if power cord is frayed or worn.

 To prevent any injury or damage this commercial appliance must be installed by a qualified electrician.

 To avoid any injury, turn the power off, unplug from the power source and allow to cool before performing any maintenance.

 To avoid electrical shock or personal injury, do not steam clean or use excessive water on this commercial appliance.

 This product has no “user” serviceable parts. To avoid injury or damage to the commercial appliance use only Authorized AccuTemp Service Agents and Genuine Replacement Parts when service is required.

 Genuine AccuTemp Replacement Parts are specified to operate safely in the environments in which they are used. Some aftermarket parts or generic replacements parts do not have the same specifications to operate safely in AccuTemp equipment. It is imperative that to use Genuine AccuTemp Replacement Parts to avoid injury or damage to the commercial appliance.

 Always disconnect from power source before cleaning or servicing.

 Any in-the-field modification that bypass the built-in safety features will result in personal injury or death.

 This appliance must be properly grounded, in accordance with all National, State or local electrical codes.

 This appliance has a totally unique design and is constructed unlike any other griddle on the market today. Any modification may permanently damage the appliance.

 This appliance must be level for proper operation and to reduce possible damage to this commercial appliance.

 This appliance is heavy, for safe handling, the installer should obtain help as needed or employ appropriate material handling equipment to remove the commercial appliance from the skid and move to the final location in the building.

 Temperatures in and around the appliance are very hot and can cause severe burns.

 To avoid damage to the cooking surface of this appliance do not use abrasive cleaners such as a griddle stone or brick.

 To avoid personal injury or damage to the appliance do not use a water jet to clean the unit.

 To avoid damage to the appliance do not leave a chlorine sanitizer in contact with the stainless steel longer than 10 minutes.

 To avoid severe burns slowly remove the grease reservoir to avoid spilling the contents. It is recommended to let it cool before removing.

 To avoid damage to the appliance do not leave a chlorine sanitizer in contact with the stainless steel longer than 10 minutes.

 To avoid severe burns slowly remove the grease reservoir to avoid spilling the contents. It is recommended to let it cool before removing.

2. General Information

2.1 Unit Specifications

Accu-Steam Gas Griddle Specifications						
Model #	GGF1201A2450-T1	GGF1201B2450-T1	GGF1201A3650-T1	GGF1201B3650-T1	GGF1201A4850-T1	GGF1201B4850-T1
BTU Firing Rate per Hour	42,300	42,300	70,000	70,000	85,000	85,000
Unit Width (A)	24.25 [616]	24.25 [616]	36.25 [921]	36.25 [921]	48.25 [1226]	48.25 [1226]
Unit/Installation Depth (D)	38.3 [973]	32.3 [820]	38.3 [973]	32.3 [820]	38.3 [973]	32.3 [820]
Cooking Surface Width (B)	23.9 [607]	23.9 [607]	35.9 [912]	35.9 [912]	47.9 [1217]	47.9 [1217]
Cooking Surface Depth (C)	30 [762]	24 [610]	30 [762]	24 [610]	30 [762]	24 [610]
Rear Leg to outside of Flue (E)	12 [305]	6 [152]	12 [305]	6 [152]	12 [305]	6 [152]
Center Left to Right Leg (F)	20 [508]	20 [508]	32 [813]	32 [813]	44 [1118]	44 [1118]
Effective Cooking Area	717 sq. in.	574 sq. in.	1077 sq. in.	862 sq. in.	1437 sq. in.	1150 sq. in.
Grease Pan Capacity	5 qt	5 qt	6 ½ qt	6 ½ qt	6 ½ qt	6 ½ qt
NEMA Plug	5-15	5-15	5-15	5-15	5-15	5-15

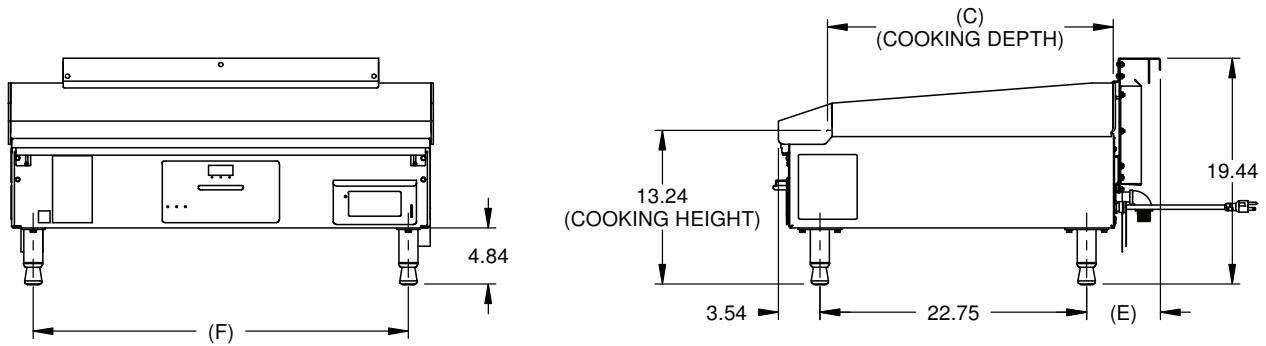

Fig 2.A

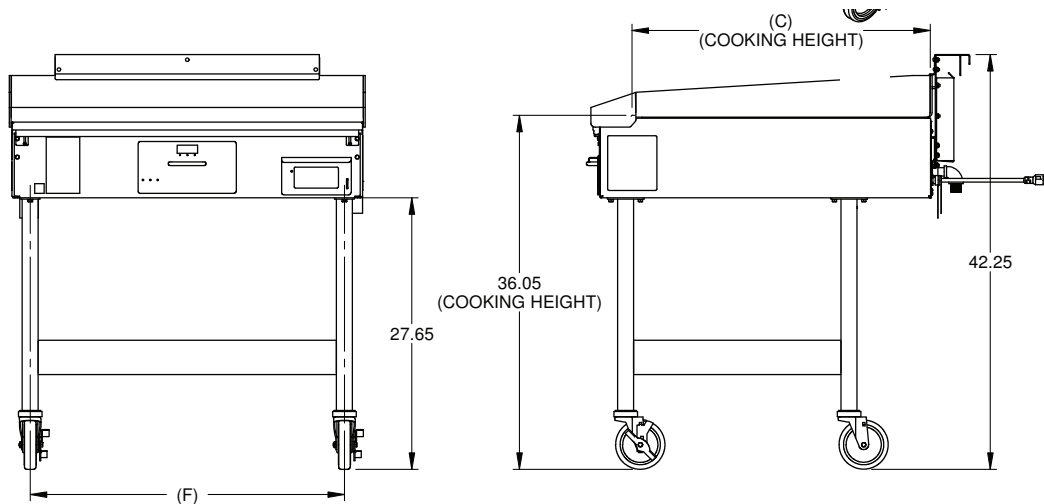

Fig 2.B

 THE UNIT SHOULD NOT BE FLUSH MOUNTED UNDER ANY CIRCUMSTANCES.

2.2 EQUIPMENT DATA PLATE

Model: **AA B CCC D E FF GG**

Example: GGF1201A4850

A is the base model N = Natural Gas, P = Propane

B is the model configuration

CCC is the supply Voltage

D is the number of phases: 1 or 3

E is the depth

F is the width

G is the special configuration

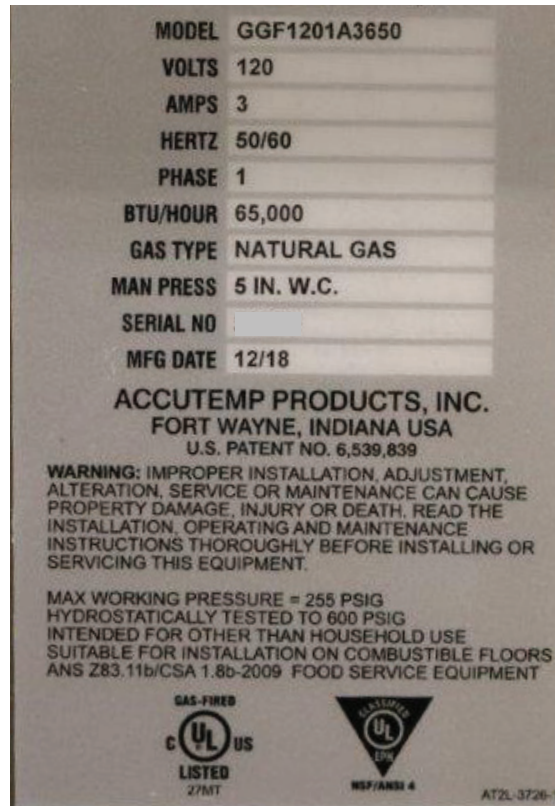



Fig 2.C

 The Serial Number is also stamped into the upper right corner of the front plate, above the grease tray.

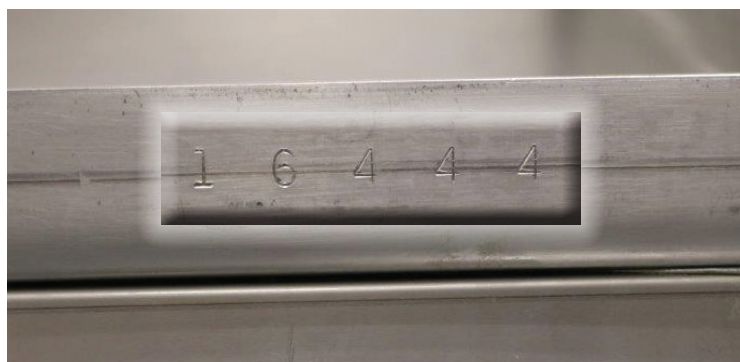

Fig 2.D



To register this AccuTemp product for warranty complete the following items:

1. Complete the Installation/Operational Checklist and Warranty Registration Form enclosed in the document packet that was sent with the appliance.
2. Mail, fax or scan and send via e-mail the form to AccuTemp Products, Inc to the contacts listed for each type on the form.

If you have any questions about warranty registration please contact our technical service group. They are available 7 days a week from 7:00 am to 7:00 PM EST.

Toll Free	800 480-0415
Office	260 469-3040
Fax	260 469-3045
Email -Service	service@AccuTemp.net
Email-Parts	parts@AccuTemp.net
Web Site	www.AccuTemp.net

Location Name:	<input style="width: 95%;" type="text"/>	Date:	<input style="width: 95%;" type="text"/>
Street Address:	<input style="width: 95%;" type="text"/>	Service Company:	<input style="width: 95%;" type="text"/>
City:	<input style="width: 95%;" type="text"/>	Street Address:	<input style="width: 95%;" type="text"/>
State/ Zip Code:	<input style="width: 95%;" type="text"/>	State/ Zip Code:	<input style="width: 95%;" type="text"/>
Building Name/#:	<input style="width: 95%;" type="text"/>	Service Phone #:	<input style="width: 95%;" type="text"/>
Contact Name:	<input style="width: 95%;" type="text"/>	Technicians Name:	<input style="width: 95%;" type="text"/>
Phone:	<input style="width: 95%;" type="text"/>	Technicians Email:	<input style="width: 95%;" type="text"/>
Email:	<input style="width: 95%;" type="text"/>	Additional Info:	<input style="width: 95%;" type="text"/>

- For proper installation, please refer to the installation and owner’s manual, which includes step-by-step instructions and a start-up checklist.
- AccuTemp Products, Inc. is not responsible for the installation process, and we do not recommend modifications to the electrical supply. Any in-field modifications made without written authorization from AccuTemp Products, Inc. will void all warranties.
- It is recommended that the wall receptacle be placed as low as state and local codes allow. Placing the receptacle in high heat zones, such as directly above, below, or beside the exhaust flue, may cause service issues not covered by the product warranty.
- If your installation site is at an altitude greater than 4,000 feet above sea level, please contact the AccuTemp Technical Services Department to confirm the appropriate orifice size for the main burners.
- An external regulator should only be used if the supply gas pressure exceeds 0.5 psig / 14” WC.

This checklist must be completed accurately and in full. To activate warranty, please submit this form to AccuTemp Warranty Department @ warranty@accutemp.net.

SERIAL NUMBER:	MODEL NUMBER:	
	YES	NO
1. Is the wall receptacle/junction box placed in a low heat zone? (Circle Y/N)	Y	N
2. When measured across the fuses, is the voltage 120V (+/- 10%) (Circle Y/N)	Y	N
3. Is the griddle being installed at an altitude greater than 4,000 feet (Circle Y/N)	Y	N
4. Is this griddle installed using the legs or stand provided? (flush mounting will void warranty) (Circle Y/N)	Y	N
5. Is the griddle level? (Circle Y/N)	Y	N
6. Is there sufficient spacing to ensure maximum airflow for proper combustion (Circle Y/N)	Y	N
7. If the griddle has legs, have the (4) rubber foot tips been installed (Circle Y/N)	Y	N
8. Is the griddle hard connected to the gas supply line? (Circle Y/N)	Y	N
9. If the griddle is connected with a 3/4” flexible commercial grade gas hose? (Circle Y/N)	Y	N
10. If yes, is a restraining device used? (Circle Y/N)	Y	N

ACCUSTEAM Gas Griddle Start Up Checklist

9. Is the supply gas pressure above 0.5 psig/14"wc? (Circle Y/N)	Y	N
10. Is an external gas regulator connected to the griddle? (Circle Y/N)	Y	N
11. Checked all internal gas fittings are secure, as some may have loosened during shipping. (Circle Y/N)	Y	N
12. What is the Length and Width of the Gas Supply Line? L _____ W _____		
13. Gas Pressure measurements Natural Gas: Supply _____ WC Manifold _____ WC Manifold pressure should be 5"WC (Regulator valve pressure tap - 1/8NPT) Propane: Supply _____ WC Manifold _____ WC Manifold pressure should be 10"WC (Regulator valve pressure tap -1/8NPT)		
14. What is the measured flame sense on the unit when the main burners are lit? <div style="text-align: right;">_____ DCuA (microampere)</div>		

Temperature Verification

1. What is the customers normal operating temperature for the Griddle?	_____ °F													
2. Using a weighted contact temperature probe with digital thermometer , does the surface temperature match the set temperature on the griddle controller? (Circle Y/N)	Y	N												
3. Does the griddle heat light cycle ON/OFF once the surface temperature has met the set temperature? (Circle Y/N)	Y	N												
4. Bring the griddle to 350°F and allow it to cycle twice. Take 9 temperatures across the surface of the unit in grid form and record (the temperatures should be consistent to $\pm 10^\circ\text{F}$): <table border="1" style="margin: 10px auto; border-collapse: collapse; text-align: center;"> <thead> <tr> <th style="padding: 5px;">LEFT</th> <th style="padding: 5px;">MIDDLE</th> <th style="padding: 5px;">RIGHT</th> </tr> </thead> <tbody> <tr><td style="height: 30px;"> </td><td> </td><td> </td></tr> <tr><td style="height: 30px;"> </td><td> </td><td> </td></tr> <tr><td style="height: 30px;"> </td><td> </td><td> </td></tr> </tbody> </table>			LEFT	MIDDLE	RIGHT									
LEFT	MIDDLE	RIGHT												
5. Does the unit operate correctly for 15 minutes after unit has reached temperature? (Circle Y/N)	Y	N												
6. Take photographs of install, including: Front of griddle, Side view of griddle, hook up and supply and submit them with the installation checklist to warranty@accutemp.net .														

I accept this checklist as complete and accurate:

Signed: _____ Restaurant Management

Print Name: _____

Date: ____/____/____

AccuTemp Products, Inc.
 19119 John Adams Drive
 New Haven IN 46774
 Email: warranty@accutemp.net
 Phone: 260.469.3040 or 800.480.0415
 Fax: 260.493.8914

3. INSTALLATION

TABLE TOP/STAND MODEL - GGF & PGF

Installation must conform with local codes , or in the absence of local codes, with the *National Fuel Gas Code, ANSI Z223.1/NFPA 54, or the Natural Gas and Propane Installation Code, CSA B149.1*, as applicable.

TOOLS REQUIRED:

Spirit Level
Phillips Screw Driver
Small Blade Straight Screw Driver
Digital Volt Meter with ability to read DCuA- for Flame Sense Measurement.
Manometer
Weighted Temperature Probe
Digital Temperature Meter

3.1 INSTALLATION NOTICE

Only qualified service technicians/electricians should perform the installation to ensure that all electrical, gas and safety requirements are met and that all wiring, gas and plumbing installations are performed in accordance with all national, state and local codes.

The installation must conform with local codes, or in the absence of local codes, with the National Fuel Gas Code, ANSA/NFPA 54, or the Natural Gas and Propane Installation Code, CSA B149.1 as applicable.

The appliance and its individual shutoff must be disconnected from the gas supply piping system during any pressure testing of that system at test pressures in excess of 1/2 PSI(3.5kPA)

3.2 UNPACKING

This appliance was carefully inspected before shipment from the factory. The transportation company assumes full responsibility for safe delivery to the customer until customer acceptance of the package. Careful inspection of the packaging and the appliance should be completed before acceptance from the transportation company.

3.3 GRIDDLE LIFTING

Griddles are heavy enough to require additional manpower or powered assistance when installing or moving the griddle.

 When moving the equipment manually make sure there are enough people for the task as the equipment is heavy.

 Make sure the equipment is not dropped during moving. People doing the carrying could be seriously injured and/or the equipment damaged. The manufacturer does not accept any responsibility for damage resulted from such actions.

3.4 LOCATION AND PLACEMENT

The AccuSteam™ gas appliance has been designed to be placed on a commercial kitchen counter-top, an AccuTemp griddle stand or directly onto any flat, non combustible level surface that will support the appliance weight.

The operating temperature ranges from 200°-400°F (93°- 204°C). Since these temperatures can also be found on surfaces around the perimeter of this commercial appliance, care should be given not to install next to or against, objects or surfaces with a low melting or flash point.

3.5 CLEARANCES

Location	Combustible Construction	Non-Combustible Construction
Back	2 Inches	0 inches
Right Side	1 Inch	0 inches
Left Side	1 inch	0 inches
Above Flue	No combustible materials above flue	6 inches
SUITABLE FOR ALL INSTALLATION ON COMBUSTIBLE FLOORS.		

3.6 LEVELING

The appliance must be installed in a level condition. An out-of-level condition may cause uneven temperatures and in a severe out of level condition damage to the appliance can occur. Use a spirit level resting on the appliance cooking surface to ensure it is level front-to-back and left-to-right.

3.7 TABLE TOP

Install the (4) rubber foot tips provided with your appliance onto the four foot adjusters of each of the commercial appliance legs. This will keep the griddle from sliding on the counter-top under normal use. Once the rubber foot tips have been installed, adjust the four foot adjusters up or down as needed to level the griddle side to side and front to back.

! THE UNIT SHOULD NOT BE FLUSH MOUNTED UNDER ANY CIRCUMSTANCES.

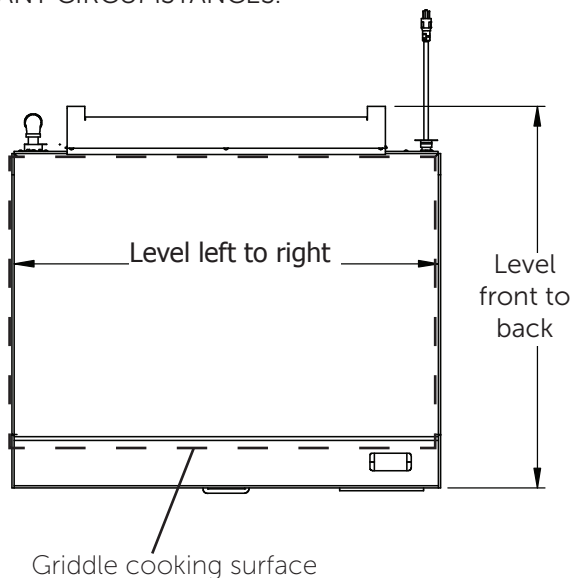

Fig 3.A

3.8 STAND INSTALLATION

! Improper installation, adjustment, alteration, maintenance or service can cause death or injury or property damage. Read the installation instructions completely before installing, maintaining or servicing this accessory.

! Use of any replacement parts other than those supplied by AccuTemp Products may cause bodily injury, damage to property, and damage to the equipment. Use of non OEM parts will void all active warranties.

! Do not touch this accessory while running as the outside will be hot and can cause a burn injury. Always wait until the accessory is cool before servicing.

! Griddles that mount to the this accessory are heavy enough to require additional people or powered assistance when installing. Failure to do so can cause injury or death.

! Operation of this accessory in an out of level condition could cause poor performance of the griddle that is mounted to it.

TOOLS REQUIRED:

Lifting device that is rated for lifting a minimum of 500 pounds to a minimum height of 26 inches
7/16" combination wrench
Inch pound torque wrench and 7/16" socket
1" Open end wrench or Adjustable wrench
Level

1. Carefully remove the packing material of the stand.
2. Locate the stand in an area where there is room to work around. If the stand model has casters, lock the front casters to the on position (Fig 3.B).

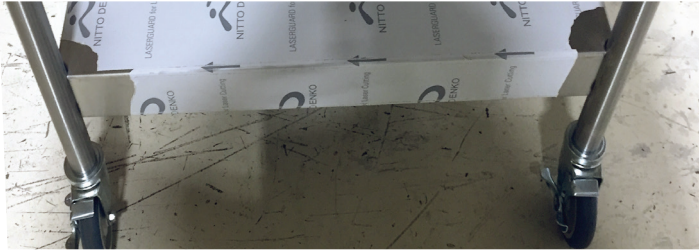

Fig 3.B

3. Using the lifting device make sure that the plate or forks extend the width of the griddle bottom to avoid damaging the griddle (Fig 3.C).

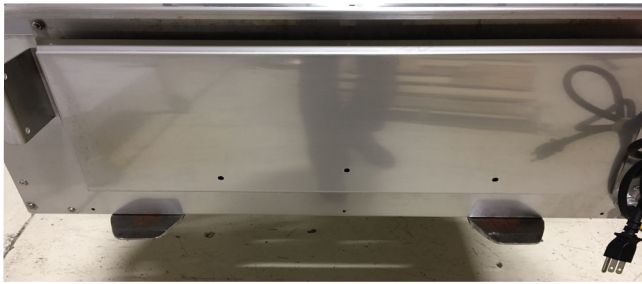

Fig 3.C

4. Raise the lifting device enough to gain access to the four shipping legs (Fig 3.D).

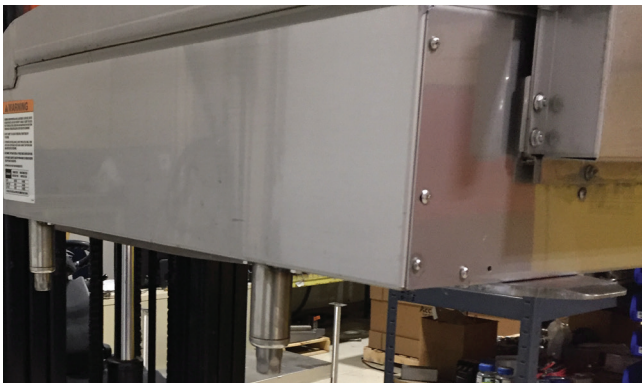

Fig 3.D

5. Remove the two fasteners that attach each of the four legs to the griddle and retain the fasteners for later use (Fig 3.E).

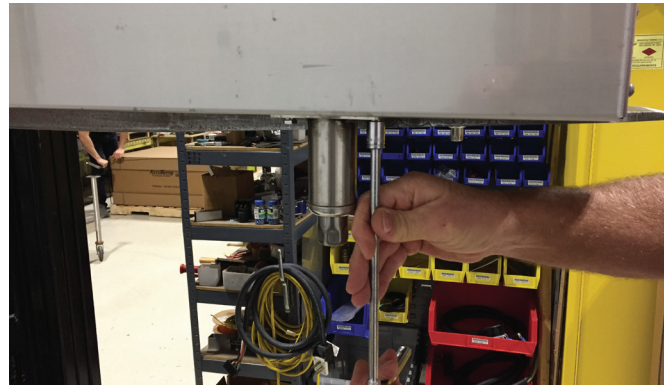

Fig 3.E

6. Raise the lifting device so that the griddle clears the mounting tabs of the stand (Fig 3.F). Align the holes in the four mounting tabs of the stand to the threaded holes of the griddle.



Fig 3.F

7. Locate the eight fasteners and lock washers removed in step 6. Place a split lockwasher on each bolt and push through the hole in the mounting tab (2 holes per mounting tab) and hand thread each into the griddle's threaded holes. Verify that the fasteners are not cross threaded (Fig 3.G).



Fig 3.G

8. Tighten each fastener to 75 inch pounds (Fig 3.H).

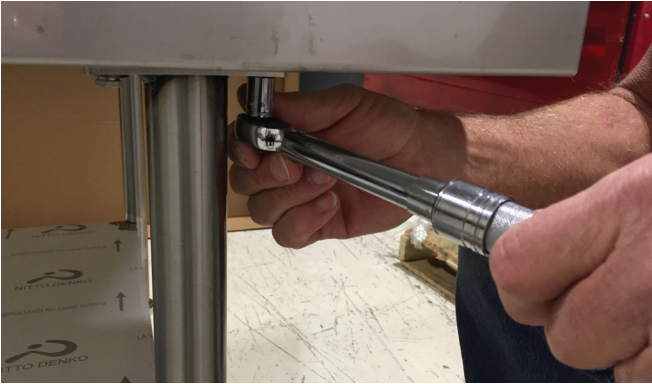

Fig 3.H

9. Stands with adjustable feet: Level the griddle using the adjustable feet from front to back and side to side by using a 1" open end wrench or adjustable wrench and turn each foot clockwise to raise and counter clockwise to lower (Fig 3.I).



Fig 3.I



Stands with casters:

If the stand is fitted with casters they can not be adjusted and the floor must be level.



This accessory carries a one year parts only warranty for manufacturing defects.

3.9 ELECTRICAL CONNECTIONS



When this appliance is installed with casters it must be installed with the casters supplied. A connector complying with either ANSI Z21.69 - CSA 6.9. It must also be installed with restraining means to the connector as specified in the appliance manufacturer's instructions.



 This commercial appliance must be properly grounded in accordance of all current National, state and local codes. Never remove the ground prong of the plug.

3.9.1 ELECTRICAL SUPPLY

The AccuSteam™ griddle has been designed, manufactured and tested to meet or exceed the demanding standards of safety set forth by *ANSI Z83.11*. To ensure that this high level of safety is maintained in your installation, it is important that you read and understand the following information before attempting to plug in your griddle.

3.8.2 ELECTRICAL REQUIREMENTS

Electrical requirements are listed on the data plate located on the front right of the control panel. All standard AccuTemp griddles are supplied with a 6ft (1.83m) cord and the appropriate UL listed plug that must be connected to a 15 Amp (120Vac) or a 20 Amp (208-240Vac) depending on the rating listed on the data plate. Make sure that the voltage at your supply receptacle is within $\pm 10\%$ of the voltage listed on the griddle data plate. Connection to any other voltage may cause damage to components in the commercial appliance. The appliance plug must be used with the appropriate receptacle.





Direct wiring will void the warranty.

3.9.3 GROUNDING INSTRUCTIONS

Grounding provides a path for electric current to reduce the risk of shock. This product is equipped with a power cord having a grounding conductor and a grounding plug. The plug must be plugged into a grounded receptacle that is installed and grounded in accordance with local codes, or in the absence of local codes, with the *National Electric Code, NFPA 70, or the Canadian Electrical Code, CSA22.2*, as applicable.

Under no circumstances shall the grounding or prong of the plug be cut off or bent to fit a receptacle other than the one supplied. Do not use any adapters to fit the receptacle.

3.10 GAS CONNECTION

-  The griddle has a 90° male 1/2" connection installed (Fig 3.L).
-  The gas supply pressures for the internal regulator must be verified with a calibrated manometer while the appliance is operating in maximum load condition.
-  A 1/8" NPT tap is provided in the front of the internal regulator to measure the burner STATIC pressure, see FIGURE Use a pipe joint compound or sealant designed for the use with liquefied petroleum gas when replacing the 1/8" NPT tap.
-  Flexible residential appliance connection hoses are not suitable for this appliance and will void any warranty.
-  Do not use an excessive amount of sealant in order to prevent potential obstruction of the gas control valve.

4. Use a 1/8" NPT tap to connect a manometer to the control valve. Ensure manometer is set to read inches water column (Fig 3.J & 3.K).
5. Turn gas and power supply on and turn unit on.
6. When unit powers on, the pilot valve will open and the STATIC pressure will be present.
7. Once unit attempts ignition, the main valve will open and the DYNAMIC pressure will register on the manometer.
8. The DYNAMIC pressure must be set to **5 Inch Water Column (NG) or 10 inch WC (Propane)**.
9. To adjust the pressure, remove the dust cap on the regulator as seen in Fig 3.J & 3.K.
10. Adjustment screw can be turned using a slot head screwdriver. Adjust while burner is on.

3.10.1 GAS PRESSURE ADJUSTMENT INSTRUCTIONS

1. Ensure unit is connected to gas supply.
2. Turn gas off at supply.
3. Remove 1/8" NPT plug from dual solenoid control valve.



Fig 3.L

Use a 1/8" NPT Barbed Pressure Tap to connect a manometer and verify pressure setting.

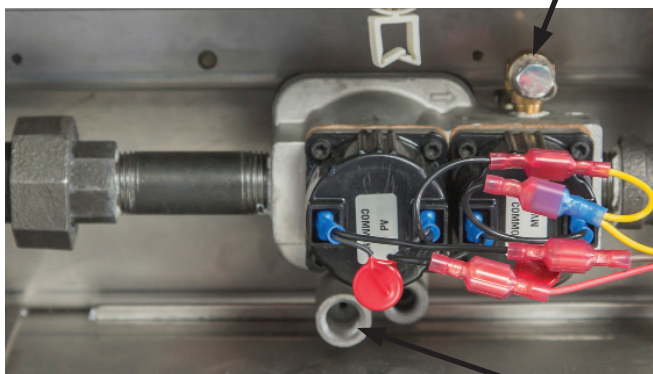

Fig 3.J - 2018 and older, valve design

Gas pressure adjustment screw



Fig 3.K - New Valve design as of 2019

3.10.2 FLAME SENSE RECTIFICATION

The AccuSteam Gas Griddle utilizes a flame sensing circuit to determine if the system has proper combustion. When the system is turned on, gas is sent to the burner and an electronic ignition tries to ignite the burner. The ignition module then checks to see if flame is established in the burner.

If the flame sense feedback is within the proper range the system will stay on until the control board ceases the call for heat.

The ignition module continues to monitor the voltage and as long as its within the proper range the burner will stay on. If the flame sense reading falls below the threshold of 0.38 DC μ A (microamperes) the griddle will go into lock out and will stop heating. The external signal for a lock-out is a 4 second flash on the FAULT light.

1. The flame sense should be monitored and recorded as part of the install.
2. To test for flame sense, Disconnect the orange wire from the flame sense.
3. Connect the probes of a multimeter capable of reading DC μ A (DC micro-amperes) to the flame sensor and orange wire.
4. Run the unit and monitor the reading.
5. If the gas pressure is set correctly for the gas type the reading should be 4 to 6 DC μ A.

3.10.3 IGNITION TROUBLESHOOTING

Should the unit trigger an ignition lockout during installation and testing, verify the following

1. Verify the flame sense is above 0.38 DC μ A.
 - a. If the reading is zero, ensure the flame sense is not grounded.
 - b. If the reading fluctuates, check for drafts that could be causing an unstable flame or loose venturi connections to the burners
 - c. Ensure the flame sense is properly placed to be engulfed by flame.
2. Double check the gas hose connection and verify pressure.
 - a. Ensure the dynamic pressure is set to 5 Inches Water Column.
 - b. Test the unit when the supply is under maximum load, ensure the static and dynamic pressures do not fluctuate.
 - c. If an external regulator is connected to the gas line, ensure its breathing vent is clear.
3. Confirm the ignition and ground probes are correctly spaced.
 - a. The probes should have a gap of 0.125 \pm .020.

4. OPERATION

 RISKS RESULTING FROM CONTACT WITH VERY HOT OBJECT:

 HOT

Hot areas may form during the cooking process, especially on the cookware, grills and the inner side of the door. Use protective gloves whenever handling hot objects. During the cooking process, do not handle cookware containing liquids or liquid foodstuffs located above eye level. Danger of burns.

 Be sure all operators read, understand and follow the information contained in this manual including caution warnings, operating instructions and safety instructions.

 Never use wet or damp gloves as moisture can conduct heat quickly.

 Keep the floor in front of the equipment clean and dry. If spills occur, clean immediately to avoid potential injuries.

 Do not use abrasive (or steel) materials, such as wire brushes, metal scouring pads to clean the griddle surface

4.1 OPERATION INTRODUCTION

The AccuSteam G2™ griddle is constructed and uses technology like no other griddle in the world. The stainless steel cooking surface is heated by steam. The griddle steam chamber requires no additional liquid or maintenance. A temperature sensor to sense temperature and an over-temperature safety shutdown system are part of the griddle assembly. At temperatures below 212°F (100°C), the chamber is actually in a vacuum, similar to that of a canning jar. At temperatures above 212°F (100°C), the chamber operates under pressure. The temperature sensor senses the temperature of the steam and reports this data to the temperature control electronics, which energizes the heating system. This system maintains the griddle cooking surface temperatures to within $\pm 5^\circ\text{F}$ (2.7°C) over the entire cooking surface and provides a near instant temperature recovery, even in the same spot on the griddle, when turning food in place.

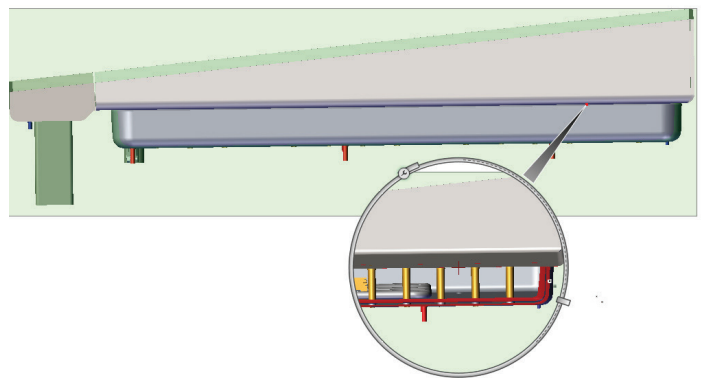

Fig 4.A

4.2 VISUAL IDENTIFICATION

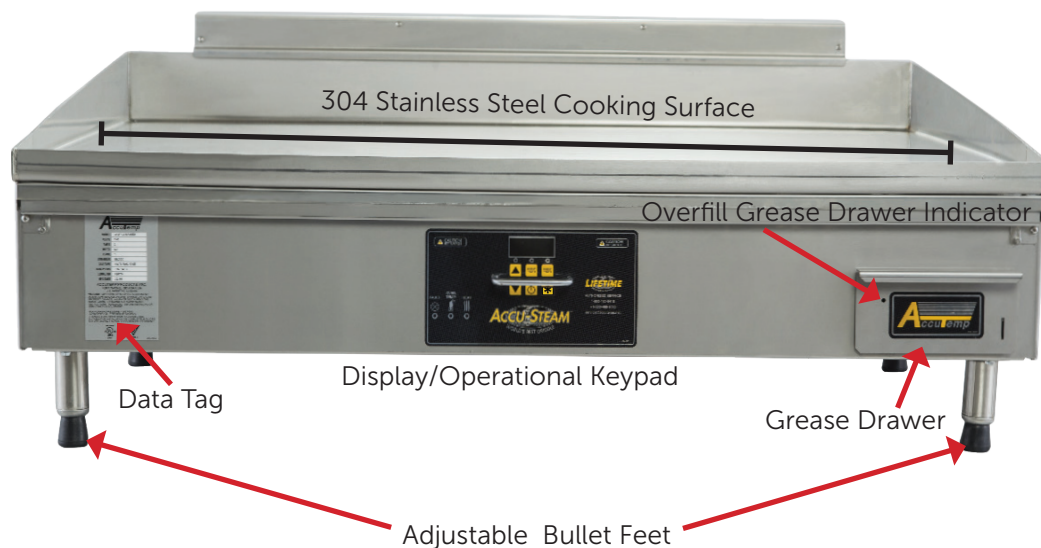

Fig 4.B

Accutemp	
MODEL	GGF1201A2450
VOLTS	120
AMPS	3
HERTZ	60
PHASE	1
BTU/HOUR	42,300
GAS TYPE	NATURAL GAS
MAN PRESS	5 IN. W.C.
SERIAL NO	16224
MFG DATE	03/16
ACCUTEMP PRODUCTS, INC. FORT WAYNE, INDIANA USA U.S. PATENT NO. 6,539,859	
WARNING: IMPROPER INSTALLATION, ADJUSTMENT, ALTERATION, SERVICE OR MAINTENANCE CAN CAUSE PROPERTY DAMAGE, INJURY OR DEATH. READ THE INSTALLATION, OPERATING AND MAINTENANCE INSTRUCTIONS THOROUGHLY BEFORE INSTALLING OR SERVICING THIS EQUIPMENT.	
MAX WORKING PRESSURE = 255 PSIG HYDROSTATICALLY TESTED TO 600 PSIG INTENDED FOR OTHER THAN HOUSEHOLD USE SUITABLE FOR INSTALLATION ON COMBUSTIBLE FLOORS ANS Z83.11/CBSA 1.8b-2009 FOOD SERVICE EQUIPMENT	

Data Tag



Operation/Fault Indicators

Display/Operational Keypad

Tech Support Contact Info

Fig 4.C

4.2 CONTROL OVERVIEW

The appliance digital temperature control is easy to operate and requires little customer interface.

OPERATOR DISPLAY AND KEYPAD

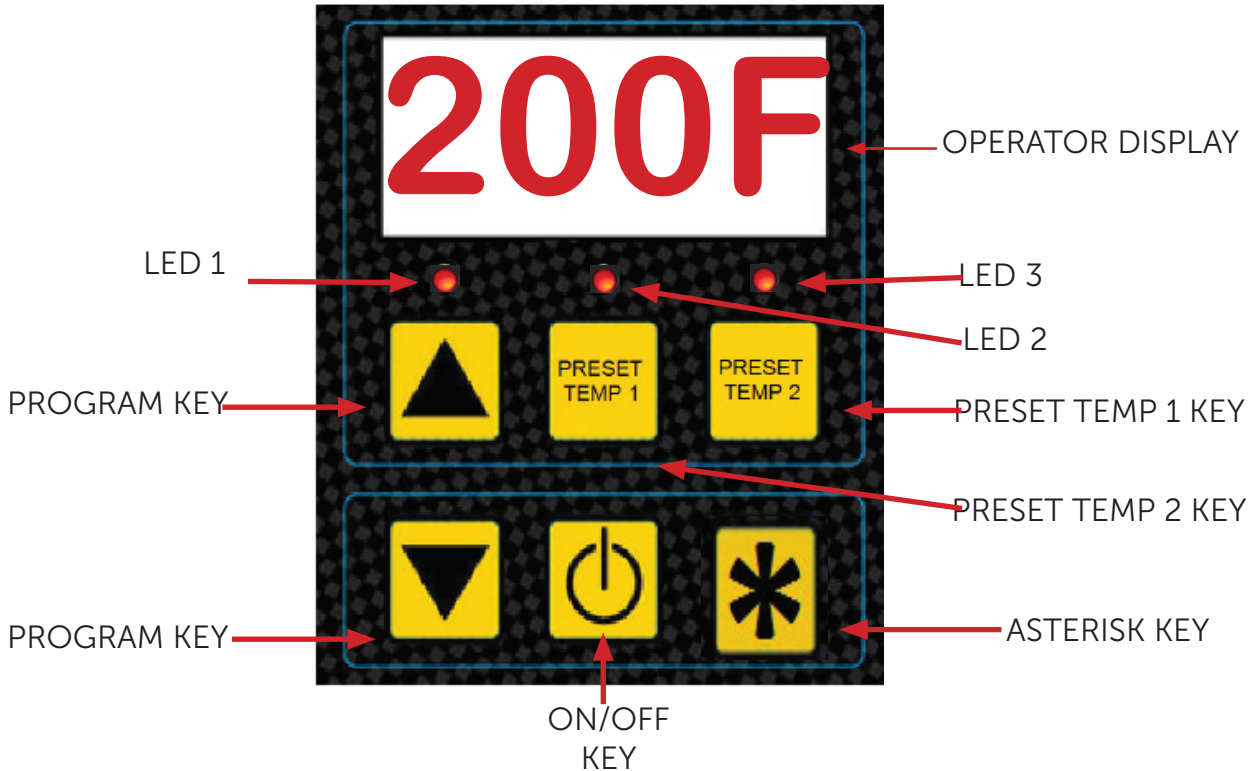



Fig 4.D

This appliance has a digital control temperature board that has two modes of operation.

- Operational Mode
- Manager Mode

Operational mode is the most used mode and the appliance operates as the keyboard overlay indicates during day to day product production.



Operational Mode Key Functions

 **ON/OFF Key** - Dual Function Key; In the "OFF" mode when pressed it turns on the griddle. When "ON" pressing and holding the key for five seconds turns the commercial appliance off.

 **Up Arrow Key** - This key when pressed will increase the set cooking temperature. Unless in the Loc mode. Press and hold key for approximately three seconds to initialize the temperature adjust mode.

 **Down Arrow Key** - This key when pressed will decrease the set cooking temperature. Unless in the Loc mode. Press and hold key for approximately three seconds to initialize the temperature adjust mode.

 **PRESET TEMP 1 and 2 Key** - When pressed and held for three seconds the system will select the preset set temperature that was set previously or the factory default temperature of 375°F for **Preset Temp 1** and 400°F for **Preset Temp 2**. LED 2 will flash for **Preset Temp 1** and LED 3 for **Preset Temp 2**.

 or  **Asterisk or Temp Display Key** - Used as a multi-function key for operation and programming. Button varies based on model.



4.2.1 PROGRAM SEQUENCE OF OPERATION

Press the **ON/OFF**  switch and the griddle will start to pre-heat and **LED 1** will blink. Any time the appliance is turned on it will operate and heat to the default set temperature or the last regulated Non-Preset temperature. **(Factory default is 350°F)**

The display will show the current temperature until the set temperature is met, then **LED 1** will go solid. (See FIG 4) The display will go to a "rdY" display or show the set temperature depending on the programming when the appliance was initially installed and setup. **(Factory default is "rdY")**



PRESETS

Press the **ON/OFF**  switch (See FIG 8) and the griddle will start to pre-heat and **LED 1** will blink.

Press and hold any **PRESET KEY**  or  for three seconds or until the LED 2 or LED 3 blinks.

The selected preset LED will blink and the display will show the current temperature and increase or decrease depending on the set temperature until it has reached the set preset temperature for that preset key and then go solid and The display will go to a "rdY" or show the set temperature depending on the programming when the appliance was initially installed and setup. The set display temperature will remain at the set temperature until the griddle is turned off and back on.

The factory defaults for the preset keys are:

 375°F
 400°F

4.2.2 MANAGER MODE PROGRAMMING

Prior to using the commercial appliance a few operational items need to be determined.

- Default set temperature
- Preset 1 set temperature
- Preset 2 set temperature
- Operator lockout of set temperatures or "on the fly" temperature set



Default Set Temperature - is the temperature that the commercial appliance will heat up to when turned on.

Preset 1 Set Temperature - is an alternative set temperature that the commercial appliance will heat up to when activated from the key-pad.

Preset 2 Set Temperature - is an alternative set temperature that the commercial appliance will heat up to when activated from the key-pad.

Set Temperature Lockout - If turned on in the manager mode will lock in the set temperatures that were last saved in memory. If not set to active (**Loc**), the set temperatures can be set lower or higher than the last saved value.

To change the preset temps, attend the following steps:

1. Power the unit on, the display will show the default temp (factory set to 350°F).
2. Hold the  UP arrow until the display reading starts to increase.
3. At this point, the  UP or  DOWN arrows can be used to increase or decrease the griddle temperature
4. Once the new desired preset point has been reached. Push and hold the PRESET button you wish to set this temperature to.
5. The unit will power off.
6. When the unit is powered back on, push and hold the PRESET button for three seconds, the new temperature should be programmed.

Managers mode is used to setup initial operational parameters for the appliance prior to the first time of production use.

Manager's mode

1. Entering Managers mode, With the unit powered OFF, press and hold the DOWN arrow key and the ASTERISK key together for about eight seconds, to initiate the programming mode. When the mode is accessed, all three LED lights will blink synchronously.
2. Once in managers mode, the display will show P00 (see Fig 4.E).
3. To scoll down through programs, use PRESET TEMP 2 and ASTERISK keys. For example, to reach default cook temperature (P01), press the PRESET TEMP 2 once.
4. To adjust the selected program, once the desired program is shown, push the UP arrow to enter program. The display will change to show the program setting
5. To change the program setting,use PRESET TEMP 2 and ASTERISK keys to increase or decrease the setting values.
6. When all changes are completed Exit the Managers mode and save the new parameters by pressing the PRESET 1 key.















Program #	Program Title	Minimum Value	Maximum Value	Default Value
P00	Degrees F or Degrees C	0 = F	1 = C	0 = F
P01	Default Cook Temperature	Minimum Temp	Maximum Temp	350F/176C
P02	Ready Mode (see table below)	0	3	0
P03	Probe 1 Offset	0	59	30
P04	Probe 1 Offset Sign	0= +	1= -	0
P05	Hysterisis 1	2	10	2
P06	Control Mode	0 = ON/OFF	1=Proportion	0 = ON/OFF
P07	Proportioning Band Time	4	10	10
P08	Proportioning Band Width	4	10	10
P09	"OFF Key" Delay (2/4 or 6 seconds)	2	6	2
P10	Factory Use Only	0	1	0
P11	RESET TO DEFAULT	0=NO	1=YES	0=NO













PROGRAMS INDICATED IN **BOLD FONT** SHOULD ONLY BE ADJUSTED BY A CERTIFIED TECHNICIAN.

Ready Mode Display Table

P02 Value	Default Display	Display when there is a UP arrow or PRESET key momentary press	Display when the ASTERISK key press
0	rdY	SET POINT	SET POINT
1	SET POINT	SET POINT	ACTUAL
2	rdY	rdY	rdY
3	SET POINT	SET POINT	SET POINT

4.2.3 CONTROL REFERENCE GUIDE

MODE	LED Indicators	DISPLAY	NOTES
Off	All LED's are off when powered down.	Off when powered down. When powered On, the controller would FLASH at a 1 Hz rate the current set temperature for 5 seconds. After this period the controller would go to Warm Up / Cool Down Mode.	To turn unit on: depress the  On/Off key. To turn off the unit, disable outputs, save the current set point temperature (see details in "Other Features") and turn off the display: press and hold the  On/Off key for approximately five seconds.
Warm Up / Cool Down	Blinking LED above the selected temperature key (LED 1, 2 or 3). If default condition then LED 1. If Preset 2 is selected then LED 3 If Preset 1 then LED 2	Actual temperature when no keys depressed, or set temperature of the Preset/Manual key when key  UP arrow key  Preset 1 key or  Preset 2 key is momentarily pressed.	Upon power-on or whenever another temperature setting is made, the unit will enter this mode and will exit this mode only when the actual temperature has regulated.
Ready Mode	LED above the selected key will be ON	Default display and alternate display options will be determined according to Program #2 value as shown in Fig 4.E & 4.F	Once has regulated, the indicator LED above the selected key will go to solid ON. For details on display operation, please refer to Program #2 value as shown in Fig 4.E & 4.F
Set Temperature (On the fly)	All indicator LEDs blinking	Set Point Value when user Lock Mode is OFF, or "Loc" when User Lock Out Mode is ON	If the User Lock Out Mode is OFF, the set temperature can be adjusted. To set the temperature, press either the  UP arrow key or the  DOWN arrow key and hold for approximately 3 seconds. The controller will load and display Default Cook Temp and enter set temperature mode. Press the  UP arrow key to increment or the  DOWN arrow key to decrement from the current temperature setting. Wait for five seconds. If there are no other key presses, the unit will auto start to the new setting. Press the  On/Off key to exit without saving.
Select Preset Temperature	Selected Preset indicator LED blinking	Set Point Value	To select an alternate preset temperature, if in  Preset Temp 1 setting, press  Preset Temp 2 key and hold for approximately three seconds. If in  Preset Temp 2 setting, press  Preset Temp 1 key and hold for approximately three seconds.

MODE	LED Indicators	DISPLAY	NOTES
Set Preset Temperature	All indicator LEDs blinking. Then the selected preset key will blink for 3 -5 seconds.	Set Point Value	Use the same process to change the temperature as detailed in Set Temperature (On the fly), to adjust the Set Temperature. Once the correct temperature is displayed, and before the five second time out, press and hold the  Preset Temp 1 key or the  Preset Temp 2 key to save the displayed value to the desired preset key and to exit this mode. Press the  On/Off key to exit without saving. Default Values:  Preset 1 = 375°F  Preset 2 = 400°F
Display Temperature Mode	Current Temperature function LED on	Actual temperature	Pressing the  Asterisk key and the  Up Arrow Key will display the current actual temperature when the unit is in Ready Mode.
User Lockout Mode	All LEDs on solid	" Loc " or " ULoc "	To Set USER LOCKOUT mode, press and hold the  On/Off key and the  Asterisk key for approximately four seconds while the controller is ON. After four seconds, the USER LOCKOUT parameter will toggle and the display will show either " Loc " or " ULoc ". When buttons are released, the controller will store the new USER LOCKOUT parameter value into NVM.  Up Arrow key (Increment) and the  Down Arrow key (Decrement) will be inoperable and the user can't store new values into the Preset 1 or 2 keys. When  Up Arrow key or the  Down Arrow key (Set temperature on the fly mode) are held for three seconds the display will show " Loc " when in the "Loc" mode

4.3 COOKING

4.3.1 CLEAN AFTER INSTALLATION

It is recommended that you clean your AccuSteam™ griddle thoroughly before using it for the first time. To clean the appliance cooking surface, just simply wash it down with a solution of mild soap and water, then rinse thoroughly with clean water and wipe dry with a clean towel.



Please use caution as temperatures on and around the griddle cooking surface could cause severe burns.

4.3.2 SEASONING

Once the cooking surface has been cleaned, turn the appliance on via the digital control key pad and set the temperature to 200°F. (93°C), and allow the griddle cooking surface to heat for 10 minutes. Using a high temperature oil, such as Pan and Grill Shortening™, Whirl™ or equivalent, pour enough to cover the entire appliance cooking surface. Do not use standard vegetable oil to season the griddle cooking surface. It may cause food to stick and result in improperly cooked food. Work this seasoning oil into the griddle surface with a regular heavy-duty scrub pad for about 5 minutes, making sure that you scrub the seasoning oil over the entire appliance cooking surface. After the entire cooking surface has been scrubbed with seasoning oil for 5 minutes, simply wipe or squeegee off excess oil from cooking surface. Your appliance is now ready to use!

If you use chemicals to clean your griddle periodically or on a schedule, you may need to repeat this process after the use of these chemicals.

Preheating

Press the **ON/OFF**  and set the desired temperature. The griddle will increase its surface temperature at an average rate of 15° F (8°C) per minute. It takes approximately 25 minutes to raise the griddle from room temperature to its maximum temperature of

400° F (204°C). The appliance will be preheated when the selected set temperature is displayed and the corresponding LED goes solid. Please use caution as temperatures on and around the griddle cooking surface could cause severe burns.

4.3.3 COOKING

Begin cooking only after the appliance has been preheated to the desired temperature. Please note these facts:

- You can cook all the way to the edges of the cooking surface because the temperature does not vary across the entire cooking surface.
- You can turn the product to the same spot because the cooking surface has near instant heat recovery.
- It will always cook the same, regardless of product load or surface coverage.

Accurate Cooking Temperatures

Because of the inaccurate surface temperatures and long recovery times common with other griddles cooking surfaces. It is doubtful you were cooking at the set temperature or the temperature you wanted. Adjust the temperature on the AccuSteam™ griddle and it will not change or vary by the location on the griddle surface. There are no hot or cold zones.

4.3.4 SURFACE TEMPERATURES

The digital temperature control and temperature sensor are more accurate than any other device to measure the cooking surface temperature in this appliance. Any other digital device may show a difference. The important use of the external temperature measuring device is to ascertain that the temperatures are within $\pm 5^{\circ}\text{F}$ across the entire cooking surface of the appliance.

Due to the construction material of the cooking surface an infrared temperature probe can't be used.

The proper measurement tools to use is a calibrated weighted temperature probe and digital temperature meter set (Fig 4.G).

A number of factors can cause surface temperature reading differences such as:

- Air movement across the appliance cooking surface can lower the temperature reading as much as 10°F from the set temperature.
- Proper calibration of the temperature measuring device.
- How long after the heat light turned off before temperature measurement was completed.





Weighted Temperature Probe



Digital Temperature Reading Device

Fig 4.G

 Assure the cooking surface is clean before measuring the surface temp. See section 4.4 for information on cleaning.

 Do not use an infrared or a mechanical temperature gauge to measure the surface temperature of the appliance as it will not be accurate and will provide a false temperature reading of the cooking surface temperature. See Fig 4.G for proper surface temperature measuring tools.

4.3.5 CHECKING SURFACE TEMPERATURES

1. Verify griddle is level front to back and side to side before attempting this procedure.
2. With the griddle plugged in, set the temperature to 300°F.
3. Place the weighted temperature probe in the center in the first 1/3rd of the griddle cooking surface on a small amount of high temperature cooking oil. Make sure that the probe is between the griddle weld stud dimples to assure a proper reading.
4. Allow the griddle to heat to the initial temperature setting.
5. Place weighted temperature probe and record temperatures according to the chart below (Fig 4.H).
6. Temperatures shall be within $\pm 5^\circ$ F of each other across the entire surface.

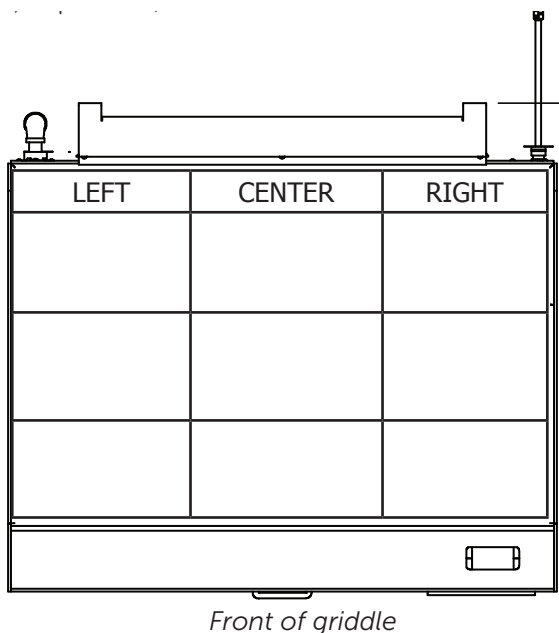



Fig 4.H - Top down view of griddle cooking surface

4.3.6 GREASE TRAY

The grease tray is located on the front right side of the appliance and has a gripping handle on the front and the inside middle to assist in safely managing the hot contents. Models used for maritime have a locking style and this lock must be released before sliding the tray out. Use caution when emptying the grease tray as contents in this tray could cause severe burns. The grease tray should be checked periodically and emptied as necessary to prevent an overflow or dangerous condition. To assist in indicating an overflow condition a hole located on the front of the tray will allow grease to escape when overfilled.

 Allow the grease tray contents to cool below 140°F before removing. Be careful not to spill the contents of the grease tray as it can cause a slipping condition which could cause a personal injury

The grease tray contents could cause severe burns. Slowly remove the grease tray from the appliance to avoid spilling the contents.

4.4 CLEANING

 Always disconnect from power source before cleaning or servicing.

 If the cooking surface of the appliance has standing grease and the griddle is at a high temperature using water or ice can cause the grease to splatter and cause skin burns.

 The grease trough contents could cause severe burns. Slowly remove the grease trough from the griddle to avoid spilling the contents.

 Do not use a water-jet to clean this appliance as it can harm the electronic components.

 Do not use a stone or brick to clean griddle cooking surface. Only use a fabric scrub pad.

4.4.1 DAILY CLEANING

Cleaning the cooking surface during the work shift can be performed with a sharp scraper. When heavy cleaning at the end of a shift or periodically through the day is needed, the following is recommended:

- Empty the grease tray as often as needed and always prior to end of shift cleaning.
- Turn the griddle off and allow it to cool to between 220°F and 240°F (104°C and 116°C). Scrape off heavy deposits and remove any standing grease before proceeding with the cleaning process.
- Use water, ice and/or griddle cleaner as needed. For example, the 3M Scotch-Brite™ Quick Clean Griddle System provides the Scotch-Brite polishing pads, quick clean liquid, pad holder and squeegee. Clean-up is very easy using these tools with the quick clean liquid, water, ice or combinations of these liquids. Seasoning the cooking surface after the daily cleaning is recommended.

- After the non-cooking surfaces are cool to the touch. Empty the grease tray and wash with a mixture of dish detergent and clean water and dry with a clean dry cloth.
- Clean the non-cooking surfaces with a damp cloth and dry with a clean dry cloth. Use a high quality stainless steel cleaner on a clean cloth to reduce grease buildup. Follow the manufacturers instructions located on the cleaner.
- It is recommended that a high quality stainless steel polish be used on the non-cooking surfaces as the last step in keeping surfaces in new like condition and lengthen the usable life of this commercial appliance. Follow the manufacturers instructions located on the polish.

Step 1

Scrape off Heavy Deposits



Step 2

Cool griddle to 220°F and apply water or ice. Use a long handled nonmetallic scrub to scrub the cooking surface.



Step 3

Add additional water or ice and using a long handle squeegee and pull to the grease tray.





Fig 4.H

5. PLANNED MAINTENANCE

 Always disconnect from power source before cleaning or servicing.

 Any in-field modification that bypass the built in safety features of this appliance will result in death or serious injury.

 Use of any replacement parts other than those supplied by AccuTemp can cause injury to the operator or damage the appliance and voids all warranties.

 There are no user-serviceable parts. To prevent electrical shock do not open the access panel covers.

 Service should be completed by AccuTemp authorized service groups. Service completed by unauthorized groups will void all factory warranties.

 AccuTemp Technical Service must be contacted for all warranty service requests. If not the warranty claim maybe denied.

5.1 IGNITER ASSEMBLY

The igniter probe ignites the main burners and depending on the kitchen cooking environment, geographic location and cleaning solutions employed, the ventilation airflow can deposit airborne material onto the probes, causing the burners to have difficulty lighting.

Required Material: nut-driver/wrench, Phillips screwdriver, stainless steel brush, a digital volt-meter able to read DC μ A (DC micro-amperes).

Tasks:

1. Remove the retaining screws and remove the probe assembly.
2. Brush all probes to remove foreign material (Fig 5.A).
3. Re-install the probe assembly and verify operation.

5.2 FLAME SENSE ASSEMBLY

The Flame Sense assembly detects a flame on the main burners and depending on the kitchen cooking environment, geographic location and cleaning solutions employed, the ventilation airflow can deposit airborne material onto the probe causing an erratic flame sense reading which can cause an ignition lock out.

Required Material: nut-driver/wrench, Phillips screwdriver, stainless steel brush, AccuTemp adaptor part number. A digital voltmeter able to read DC μ A.

Tasks:

1. Remove the retaining screws and remove the probe assembly.
2. Brush all probes to remove foreign material (Fig 5.B).
3. Re-install the probe assembly and verify operation.
4. To test for flame sense, Disconnect the orange wire from the flame sense.
5. Connect the probes of an multimeter capable of reading DC μ A (DC micro-amperes) to the flame sensor and orange wire.

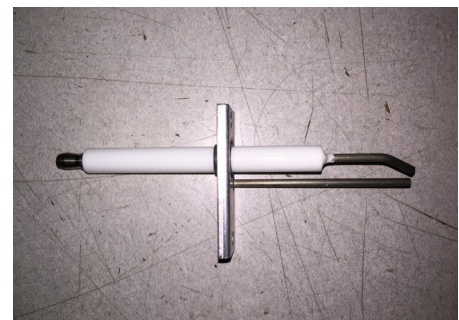

Fig 5.A

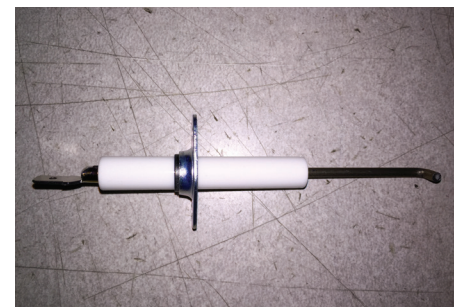

Fig 5.B

5.3 ORIFICES AND BURNER VENTURI

Burner orifices can collect dust and grease over time in any kitchen environment. If this material blocks the orifices, the appliance will be less efficient and can cause intermittent operation or complete shutdown.

Depending on the size of your appliance, there are a minimum of 2 and a maximum of 3 orifices that require inspection and cleaning. Each burner will have an orifice.

Required Material: towel, soap and warm water, stiff wire smaller than the orifice nozzle or orifice drill of the same size hole.

Tasks:

1. Remove the orifice
2. Dampen a towel with the soap and water solution and clean the orifice.
3. Take the stiff wire or orifice drill and insert it into the hole in the center of the orifice and run it back and forth, making sure all foreign material is removed.
4. Reinstall the orifice.
5. Clean the burner venturi opening so that it is free of any collected dust, grease and any other foreign material.

5.4 GAS PRESSURE

The appliance requires the proper gas pressure setting to operate properly. All pressure readings should be taken after the unit has reached a temperature of at least 200°F and while it is running to ensure proper flow rates.

Required Material: Manometer with test hoses, 1/8" NPT barbed hose fitting.

Tasks:

1. Verify the pressure regulator vent is clear before making any pressure adjustments. Remove the 1/8" NPT pipe plug from the main gas valve and install the 1/8" NPT barbed hose fitting. Tighten and mount one length of the rubber hose.
2. Allow the appliance to heat up to at least 200°F. First, check the main burner regulator pressure. Remove the rubber hose and replace with the manometer tube. The pressure should be 5" WC for natural gas and 10"WC for propane. If the pressure does not meet or exceeds these values, remove the cap on the main burner pressure regulator and adjust it to the necessary value.
3. Replace the hose fittings with original pipe plugs.
4. Check for gas leaks.

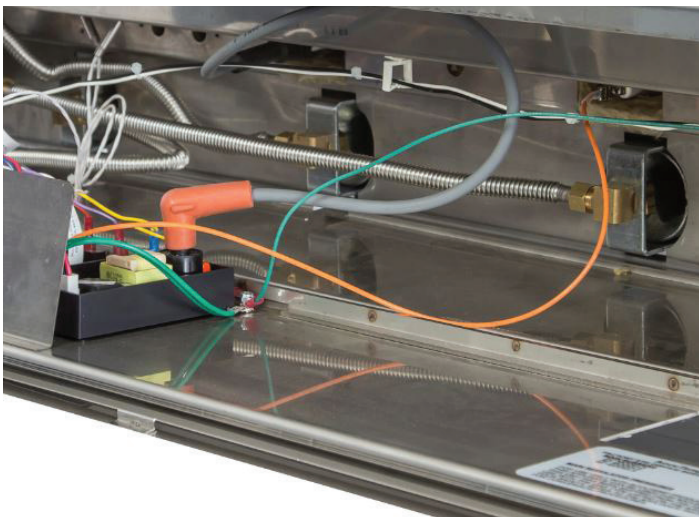

Fig 5.C

5.5 PLANNED MAINTENANCE CHECKLIST





It is recommended that you contact your AccuTemp authorized service provider to setup a planned maintenance program to keep your appliance operating in the most efficient manner. AccuTemp recommends a minimum of a yearly schedule.

PM DESCRIPTION	GENERAL ITEMS	BIANNUAL ITEMS	ANNUAL ITEMS
Verify that the appliance is level and properly located under the hood.		X	X
Verify that the temperature controller is working properly and that there are no rips in the overlay.	X	X	X
Check that the splash shield at the top of the control panel is under the rail provided. If not water and or grease can migrate and cause possible damage to the internal electronic components.		X	X
Inspect the control compartment for foreign particulate and any loose wiring connections.		X	X
A back draft diverter has been installed at the factory this will keep scraping from spatulas from dropping down the flue and will provide addition protection from back drafts that can effect stand-by burner operation. Check that flue has not been pushed in resulting in an uneven opening across the flue passage. Pull flue out so that flue opening is even across width of appliance.		X	X
Verify the operation and condition of the igniter and flame sense probe assembly. Probes should be cleaned with a wire brush and/or emery cloth. Caution: DO NOT use any abrasive that contains silica. This will leave a coating on the flame sensor that could cause the unit not to light.		X	X
Clean all burner orifices, making sure that each orifice is clear and unobstructed. It may be necessary to use a drill the same size of the orifice, if very soiled.		X	X
Inspect the burner venturi tubes for foreign particulate. Wipe out with a mild detergent and warm water and rinse with clean water.		X	X
Inspect combustion chamber and the burner tiles. If water stains are present on tiles check that tiles have no cracks and haven't sunk into the burner. Replace burners if this condition is present.			X
Inspect the ignition wire harness for any evidence of high temperature degradation or grease build-up on harness connector. Spray contact cleaner into white connector and clean mating connector imbedded in ignition module. Coat the pins with a dielectric grease.		X	X
Verify main burner regulator pressures are correct.		X	X
Verify flame sense operation		X	X

6. SERVICE & TROUBLESHOOTING

 Always disconnect from power source before cleaning or servicing.

 Any in-field modification that bypass the built in safety features of this appliance will result in death or serious injury.

 Use of any replacement parts other than those supplied by AccuTemp can cause injury to the operator or damage the appliance and voids all warranties.

 There are no user-serviceable parts. To prevent electrical shock do not open the access panel covers.

 Service should be completed by AccuTemp authorized service groups. Service completed by unauthorized groups will void all factory warranties.

 AccuTemp Technical Service must be contacted for all warranty service requests. If not the warranty claim maybe denied.

6.1 APPLIANCE WILL NOT TURN ON

- Make sure the appliance is plugged in.
- Check the facility circuit breaker (or fuse) supplying the unit

6.2 HEAT LIGHT WILL NOT COME ON

- Make sure the appliance is not hotter than the temperature you have it set for. If you have turned down the temperature of the griddle, the heat light will not come on again until the cooking surface drops below the temperature you have set.
- See if the heat light is coming on intermittently. While operating in a normal condition, the heat light cycles on and off periodically when at temperature.

6.3 UNEVEN OR INACCURATE SURFACE TEMPERATURES

- Verify the appliance is level front to back and side to side.
- Verify the surface temperature with an accurate digital surface probe thermometer.
- Use of an infrared or mechanical thermometer will not give an accurate reading of the appliance cooking surface temperatures.
- Contact AccuTemp Technical Service for additional instructions.

6.4 UNIT WILL NOT TURN OFF

- This symptom, which is extremely rare, indicates a serious control malfunction.
- Turn off the appliance electrical supply at the source and contact AccuTemp Technical Service for additional instructions.
- Make sure to hold the On/Off Key for a minimum of 3 seconds until the display turns off.

6.5 PRESET TEMPERATURES ARE NOT WORKING

- Check the preset temperature by pressing each key momentarily to display the Preset Temp. If the Preset Temp settings are correct and the appliance will not regulate to the Preset Temp contact AccuTemp.

6.6 ERROR CODE DISPLAYED

E001 Displayed

Open Temperature Sensor or defective temperature input on Temperature Control Board.

E002

Shorted Temperature Sensor or defective input on the Temperature Control Board.

6.7 FAULT LIGHT ILLUMINATED

When this error is lit an ignition failure of the appliance has occurred. Following the following steps:

1. Turn the appliance off
2. Verify that your flexible quick connect gas line is fully engaged to the appliance gas input connection if applicable.
3. Verify your gas shutoff valve is turned on to supply gas to the appliance.
4. Once these have been verified and 1 minute has passed since it was turned off turn the appliance on.

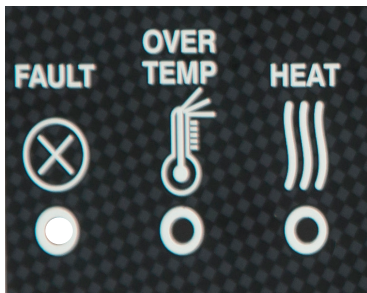

Fig 6.A
Fault Light

6.8 OVER-TEMP LIGHT ILLUMINATED

When this error is lit an over-temp condition was sensed and will turn off the appliance

To correct, turn the appliance off and wait one minute and turn the appliance back on.

If problem persists - call AccuTemp Service

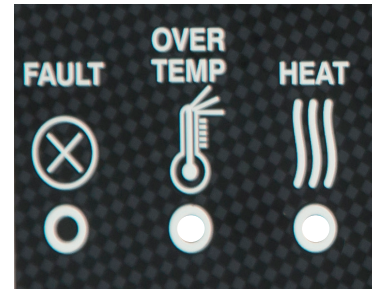



Fig 6.A
Over-Temp Light
(Heat light will also be illuminated in normal operation)

An AccuTemp Products, Inc. Technical Service Technician is available:
Monday thru Sunday, 7:00am to 7:00pm EST.

Toll Free	800 480-0415
Office	260 469-3040
Fax	260 469-3045
Email -Service	service@AccuTemp.net
Email-Parts	parts@AccuTemp.net
Web Site	www.AccuTemp.net

WARRANTY SERVICE PROCEDURE

- Contact the AccuTemp Technical Service group for all warranty service requests.
- Be prepared to supply the serial number, address, location phone and contact for the location.
- Be prepared to complete a few simple tasks to help evaluate the problem.
- If the problem requires service at the location the AccuTemp Technical Service group will dispatch the nearest authorized service agent.

 Service should be completed by AccuTemp authorized service groups. Service completed by unauthorized groups will void all factory warranties.

 AccuTemp Technical Service must be contacted for all warranty service requests. If not the warranty claim maybe denied.

7. PRODUCT WARRANTY

7.1 U.S. & CANADA SALES ONLY

LIMITED WARRANTY One Year Labor and Parts

AccuTemp Products, Inc. (AccuTemp) warrants that your AccuTemp equipment will be free of defects in material and workmanship under normal use for a period of twelve (12) months from installation or fifteen (15) months from date of shipment from AccuTemp, whichever date first occurs (the Warranty Period).

Registration of AccuTemp equipment is required at time of installation.

Damage to AccuTemp equipment that occurs during shipment must be reported to the carrier, and is not covered under this warranty. The reporting of any damage during shipment is the sole responsibility of the commercial purchaser/user of such AccuTemp equipment.

AccuTemp provides an active service department, which should be contacted and advised of service issues regardless of warranty period.

During the warranty period, AccuTemp agrees to repair or replace, at its option, F.O.B. factory, any part which proves to be defective due to defects in material or workmanship, provided the equipment has not been altered in any way and has been properly installed, maintained, and operated in accordance with the instructions in the AccuTemp Owners Manual.

During the warranty period, AccuTemp also agrees to pay for any factory authorized equipment service agency (within the continental United States and Canada) for reasonable labor required to repair or replace, at our option, F.O.B. factory, any part which proves to be defective due to defects in materials or workmanship, provided the service agency has received advance approval from AccuTemp factory service to perform the repair or replacement. This warranty includes travel time not to exceed two hours and mileage not to exceed 50 miles (100 miles round trip), but does not include post start-up assistance or training, tightening of loose fittings or external electrical connections, minor adjustments, gaskets, maintenance, or cleaning. AccuTemp will not reimburse the expense of labor required to replace parts after the expiration of the warranty period.

Proper installation is the responsibility of the dealer, owner-user, or installing contractor and is not covered by this warranty. While AccuTemp products are built to comply with applicable standards for manufacturers, including Underwriters Laboratories (UL) and National Sanitation Foundation (NSF), it is the responsibility of the owner and the installer to comply with any applicable local codes that may exist.

AccuTemp makes no other warranties or guarantees, whether expressed or implied, including any warranties of performance, merchantability, or fitness for any particular purpose. AccuTemp's liability on any claim of any kind, including negligence, with respect to the goods and services covered hereunder, shall in no case exceed the price of the goods and services, or parts thereof, which gives rise to the claim. In no event shall AccuTemp be liable for special, incidental, or consequential damages, or damages in the nature of penalties.

This constitutes the entire warranty, which supersedes and excludes all other warranties, whether written, oral, or implied.

IMPORTANT

Improper installation can affect your warranty. Installation is the responsibility of the Dealer, Owner/User or the Installation Contractor. See: Section One, Installation of the Owners Manual.

For Service Call 800-480-0415 or email: service@AccuTemp.net

7.2 INTERNATIONAL WARRANTY

AccuTemp LIMITED WARRANTY One Year Parts Only

AccuTemp Products, Inc. (AccuTemp) warrants that all the components of the AccuTemp equipment will be free of defects in material and workmanship under normal use for a period of one year from date of installation and fifteen months from date of shipment from AccuTemp. Registration of AccuTemp equipment is required at the time of installation.

Damage to AccuTemp equipment that occurs during shipment must be reported to the carrier, and is not covered under this warranty. The reporting of any damage during shipment is the sole responsibility of the commercial purchaser/user of such AccuTemp equipment.

AccuTemp provides an active service department, which should be contacted and advised of service issues, regardless of the warranty period. During the warranty period, AccuTemp agrees to repair or replace, at its option, F.O.B. factory, any part which proves to be defective due to defects in material or workmanship, provided the equipment has not been altered in any way and has been properly installed, maintained, and operated in accordance with the instructions in the AccuTemp Installation/Operator's Manual. Exception: All gaskets are covered for a period of 90 days from installation of the equipment or 180 days from shipment if it is a manufacturing defect.

Proper installation is the responsibility of the dealer, owner-user, or installing contractor and is not covered by this warranty. Improper installation can affect your warranty. Installation is the responsibility of the Dealer, Owner/User or the Installation Contractor. While AccuTemp products are built to comply with applicable standards for manufacturers, including Underwriters Laboratories (UL) and Underwriters Laboratories Sanitation requirements, it is the responsibility of the owner and the installer to comply with any applicable local codes that may exist.

AccuTemp makes no other warranties or guarantees, whether expressed or implied, including any warranties of performance, merchantability, or fitness for any particular purpose. AccuTemp liability on any claim of any kind, including negligence, with respect to the goods and services covered hereunder, shall in no case exceed the price of the goods and services, or parts thereof, which gives rise to the claim. In no event shall AccuTemp be liable for special, incidental, or consequential damages, or damages in the nature of penalties.

This constitutes the entire warranty, which supersedes and excludes all other warranties, whether written, oral, or implied.

IMPORTANT

Improper installation can affect your warranty. Installation is the responsibility of the Dealer, Owner/User or the Installation Contractor. See: Section One, Installation of the Owner's Manual.

For Service assistance call 800-480-0415 or email: service@AccuTemp.net

LIFETIME[™]
SERVICE & SUPPORT
1-800-480-0415 | service@accutemp.net

IMPORTANT SERVICE INFORMATION

AccuTemp Product, Inc. Technical & Customer Support Technician is available Monday thru Sunday, 7:00am to 7:00pm EST.

800.480.0415 or 260.469.3040